



Industriebatterien – Network Power
Sonnenschein A500
Das starke, universelle Sicherheitspaket.

Technische Informationen

Wenn Zuverlässigkeit bei der Stromversorgung im Vordergrund steht.

Spezifikationen









- Die Produktüberlegenheit der Sonnenschein A500-Batterien ergibt sich aus der weltweit erprobten und erfolgreichen dryfit-Technologie
- Hervorragende Energiespeichereigenschaften verbunden mit hoher Zuverlässigkeit
- Entwickelt unter Berücksichtigung der IEC 60896-21/-22
- Wartungsfrei (kein Wasser nachfüllen) über die gesamte Brauchbarkeitsdauer aufgrund der Sonnenschein dryfit-Technologie
- Nennkapazität 1,2 – 200 Ah C₂₀
- 7 Jahre Design Life bei einer Umgebungstemperatur von 20 °C (80% Restkapazität von C₂₀)
- EUROBAT Klassifikation: General purpose
- Gitterplatten in Blei-Calcium-Legierung
- Extrem gasungsarm durch innere Gas-Rekombination
- Sehr niedrige Selbstentladungsrate und somit lange lagerfähig
- Kurze Wiederaufladezeiten
- Tiefentladesicher
- Keinerlei Transportbeschränkungen betriebsbereiter Blöcke, weder auf der Schiene, auf der Straße, zu Wasser noch in der Luft (nach IATA, DGR Satz A67)
- Vollständig recycelbar



Applikationen

Neben der vielseitigen Einsetzbarkeit auf dem Gebiet der Telekommunikation, in Gefahrenmeldeanlagen, in USV-Anlagen, im Bereich der Sicherheitstechnik, der Medizin- und Bahntechnik sowie in allen anderen Bereichen der Sicherheitsstromversorgung sind die Sonnenschein A500-Batterien absolut verlässliche Energiespeicher.



 Design Life in Jahren: 7	 Nennkapazität 1,20 – 200 Ah	 Blockbatterie	 Gitterplatte
 Recyclebar	 Verschlossen	 Tiefentladesicher	 Wartungsfrei (kein Wasser nachfüllen)

Typ	Sachnummer	Nennspannung V	Nennkapazität C ₂₀ 1,75 V/Z 20 °C Ah	Max. Belastung** ca. A	Länge (l) max. mm	Breite (b/w) max. mm	Höhe bis Deckeloberkante (h1) max. mm	Höhe über Anschluss (h2) max. mm	Gewicht ca. kg	Innenwiderstand mOhm	Kurzschlussstrom A	Anschluss
A502/10 S	NGA5020010HSOSA	2	10,0	80,0	52,9	50,5	94,5	98,4	0,70	11,2	189	S-4,8
A504/3,5 S	NGA50403D5HSOSA	4	3,50	60,0	90,5	34,5	60,5	64,4	0,50	48,0	88,0	S-4,8
A506/1,2 S	NGA50601D2HSOSA	6	1,20	40,0	97,3	25,5	51,0	55,6	0,33	165	38,0	S-4,8
A506/3,5 S	NGA50603D5HSOSA	6	3,50	60,0	135	34,8	60,5	64,4	0,70	71,0	88,0	S-4,8
A506/4,2 S	NGA50604D2HSOSA	6	4,20	60,0	52,0	62,3	98,0	102	0,90	63,8	98,0	S-4,8
A506/6,5 S	NGA50606D5HSOSA	6	6,50	80,0	152	34,5	94,5	98,4	1,30	48,0	131	S-4,8
A506/10 S*	NGA5060010HSOSA	6	10,0	80,0	152	50,5	94,5	98,4	2,10	34,0	189	S-4,8
A508/3,5 S	NGA50803D5HSOSA	8	3,50	60,0	179	34,1	60,5	64,4	1,00	95,0	88,0	S-4,8
A512/1,2 S*	NGA51201D2HSOSA	12	1,20	40,0	97,5	49,5	51,0	54,9	0,65	330	38,0	S-4,8
A512/2 S*	NGA5120002HSOSA	12	2,00	40,0	179	34,1	60,5	64,4	1,00	172	73,0	S-4,8
A512/3,5 S*	NGA51203D5HSOSA	12	3,50	60,0	135	66,8	60,5	64,4	1,50	142	88,0	S-4,8
A512/6,5 S*	NGA51206D5HSOSA	12	6,50	80,0	152	65,5	94,5	98,4	2,60	95,0	131	S-4,8
A512/10 S*	NGA5120010HSOSA	12	10,0	80,0	152	98,0	94,5	98,4	4,00	66,0	189	S-4,8
A512/16 G5*	NGA5120016HSOBA	12	16,0	200	181	76,0	167	167	6,00	24,2	512	G-M5
A512/25 G5*	NGA5120025HSOBA	12	25,0	200	167	176	126	126	9,60	21,3	583	G-M5
A512/30 G6*	NGA5120030HSOBA	12	30,0	400	197	132	161	180	11,1	13,1	932	G-M6
A512/40 A*	NGA5120040HSOCA	12	40,0	400	210	175	175	175	14,5	11,6	1069	A-Terminal
A512/40 G6*	NGA5120040HSOBA	12	40,0	400	210	175	175	175	14,6	11,6	1069	G-M6
A512/55 A	NGA5120055HSOCA	12	55,0	400	261	135	208	230	18,8	8,90	1403	A-Terminal
A512/60 A	NGA5120060HSOCA	12	60,0	400	278	175	190	190	20,8	6,60	1887	A-Terminal
A512/60 G6	NGA5120060HSOBA	12	60,0	400	278	175	190	190	20,8	6,60	1887	G-M6
A512/65 A	NGA5120065HSOCA	12	65,0	400	353	175	190	190	24,0	8,50	1471	A-Terminal
A512/65 G6	NGA5120065HSOBA	12	65,0	400	353	175	190	190	24,0	8,50	1471	G-M6
A512/85 A*	NGA5120085HSOCA	12	85,0	600	330	171	213	236	30,0	6,20	2017	A-Terminal
A512/115 A	NGA5120115HSOCA	12	115	770	286	269	208	230	40,0	4,60	2660	A-Terminal
A512/120 A	NGA5120120HSOCA	12	120	770	513	189	195	223	41,0	5,20	2475	A-Terminal
A512/140 A	NGA5120140HSOCA	12	140	770	513	223	195	223	47,0	4,10	3132	A-Terminal
A512/200 A	NGA5120200HSOCA	12	200	770	518	274	216	238	67,0	3,50	3605	A-Terminal

* VDS-Zulassung

** max. Belastung nur bei entsprechender Gegenkontaktierung

Gehäuse, Zulassung, Anschluss und Drehmoment

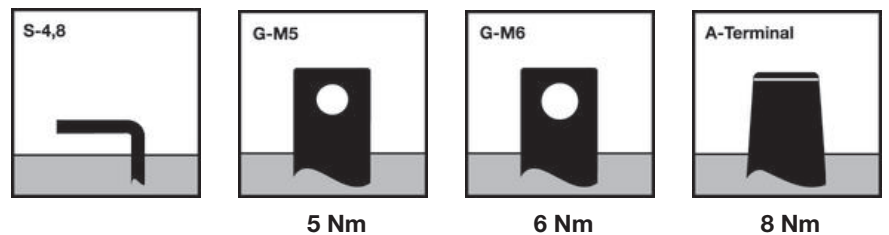

Gehäuse: 1,2 – 16 Ah = ABS
25 – 200 Ah = Polypropylen (PP)

Zulassung: Underwriters Laboratories (UL), USA
VdS (Typen siehe oben)
DIN/Gost/TÜV, Russland

A502/10 S

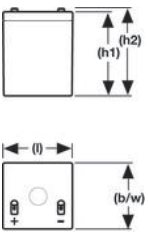

A504/3,5 S

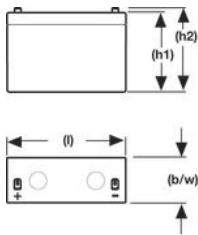

A506/1,2 S

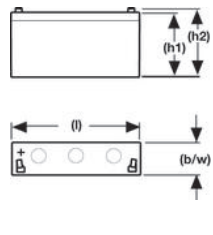

A506/3,5 S

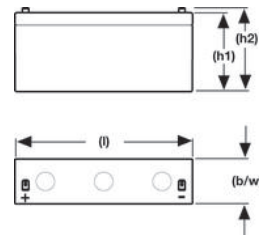

A506/4,2 S

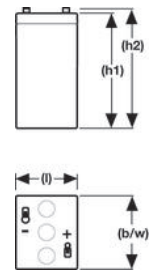

A506/6,5 S

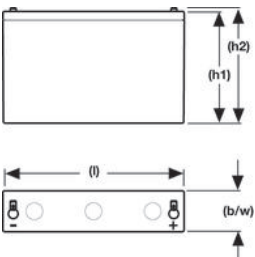

A506/10 S

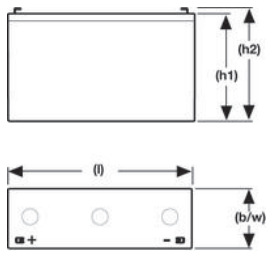

A508/3,5 S

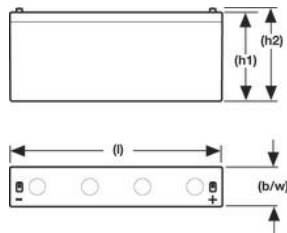

A512/1,2 S

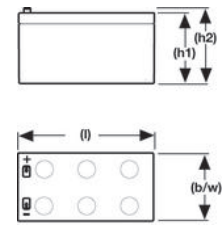

Nicht maßstäblich!

* Abmessungen gelten auch für andere Polvarianten.

A512/2 S

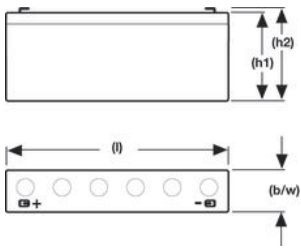

A512/3,5 S

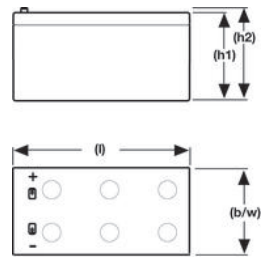

A512/6,5 S

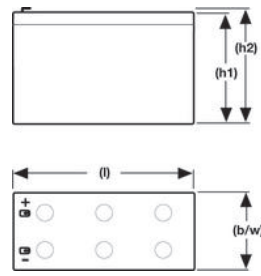

A512/10 S

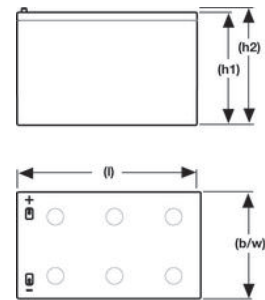

A512/16 G5

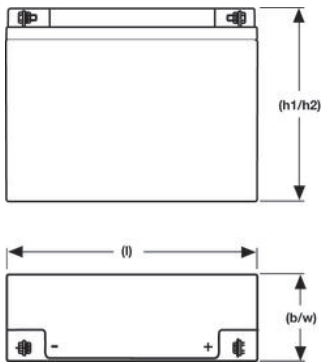

A512/25 G5

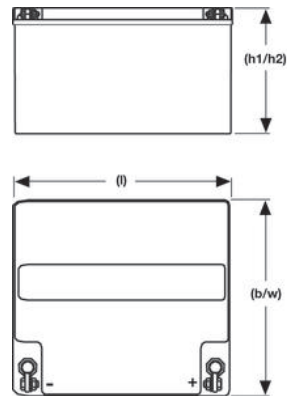

A512/30 G6

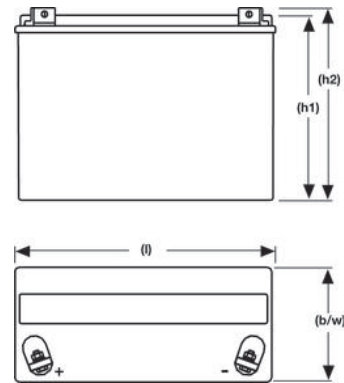

A512/40 A
(A512/40 G6)*

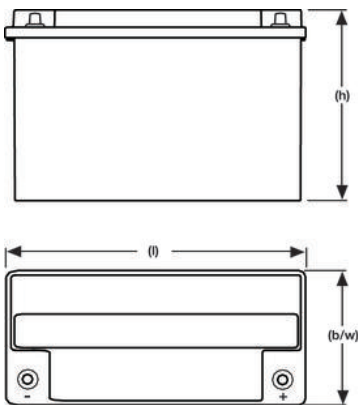

A512/55 A

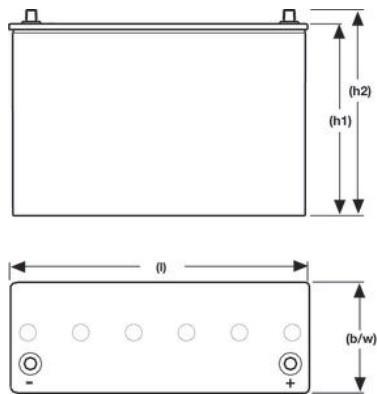

A512/60 A
(A512/60 G6)*

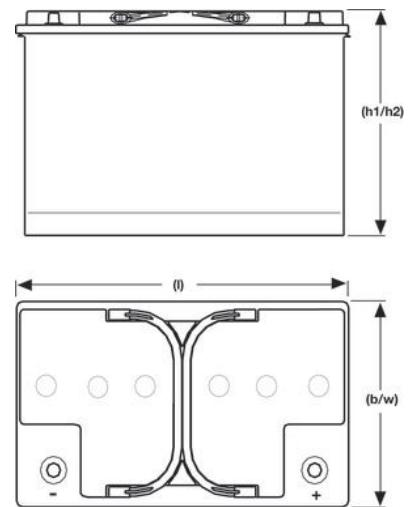

A512/65 A
(A512/65 G6)*

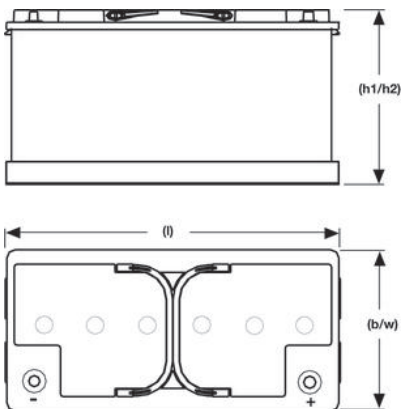

A512/85 A

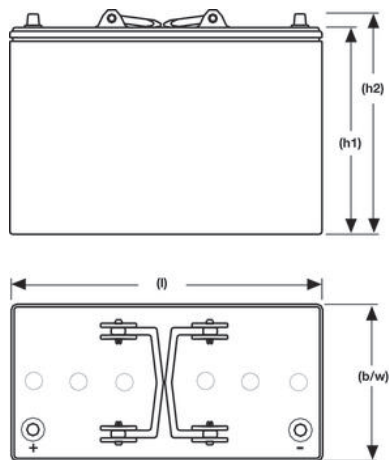

A512/115 A

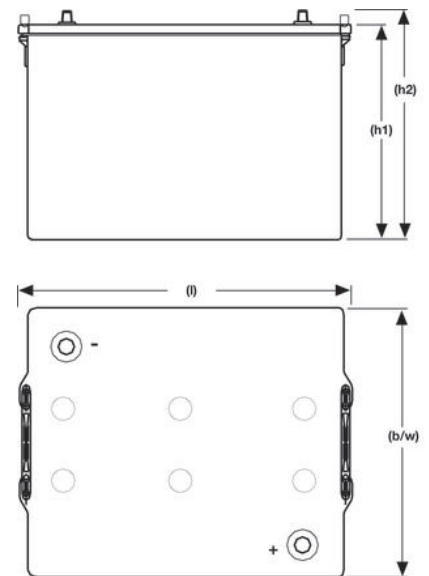

Nicht maßstäblich!

* Abmessungen gelten auch für andere Polvarianten.

A512/120 A

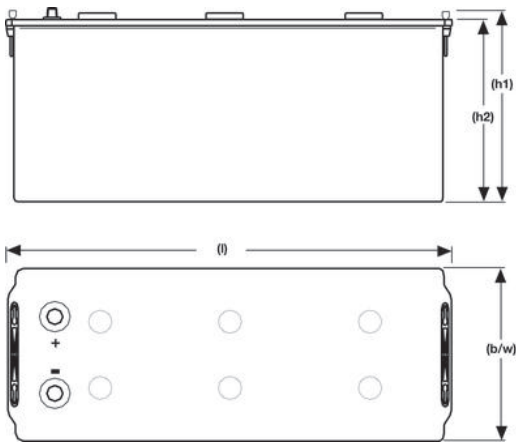

A512/140 A

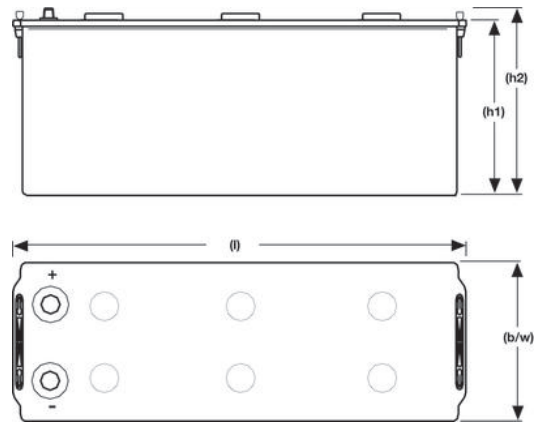

A512/200 A

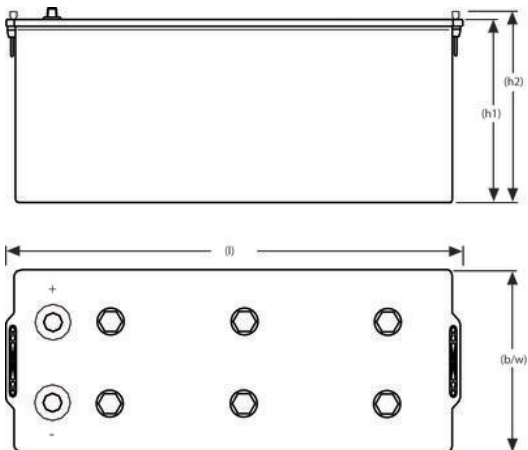

1,85 V/Z – Entladung in A bei 20 °C

Typ	Sachnummer	5 min	10 min	20 min	30 min	1 h	3 h	5 h	8 h	10 h
A502/10 S	NGA5020010HS0SA	30,0	22,0	15,0	11,2	6,40	2,80	1,80	1,18	0,96
A504/3,5 S	NGA50403D5HS0SA	9,50	6,70	4,50	3,40	2,10	0,95	0,60	0,39	0,32
A506/1,2 S	NGA50601D2HS0SA	3,52	2,44	1,58	1,20	0,75	0,34	0,21	0,13	0,10
A506/3,5 S	NGA50603D5HS0SA	9,50	6,70	4,50	3,40	2,10	0,95	0,60	0,39	0,32
A506/4,2 S	NGA50604D2HS0SA	9,90	6,30	4,20	3,40	2,40	1,22	0,75	0,49	0,39
A506/6,5 S	NGA50606D5HS0SA	17,0	12,0	8,10	6,10	3,60	1,50	1,10	0,73	0,61
A506/10 S	NGA5060010HS0SA	30,0	22,0	15,0	11,2	6,40	2,80	1,80	1,18	0,96
A508/3,5 S	NGA50803D5HS0SA	9,50	6,70	4,50	3,40	2,10	0,95	0,60	0,39	0,32
A512/1,2 S	NGA51201D2HS0SA	3,52	2,44	1,58	1,20	0,75	0,34	0,21	0,13	0,10
A512/2 S	NGA5120002HS0SA	5,40	3,70	2,60	2,00	1,50	0,56	0,34	0,22	0,18
A512/3,5 S	NGA51203D5HS0SA	9,50	6,70	4,50	3,40	2,10	0,95	0,60	0,39	0,32
A512/6,5 S	NGA51206D5HS0SA	17,0	12,0	8,10	6,10	3,60	1,50	1,10	0,73	0,61
A512/10 S	NGA5120010HS0SA	30,0	22,0	15,0	11,2	6,40	2,80	1,80	1,18	0,96
A512/16 G5	NGA5120016HS0BA	40,0	29,0	20,0	15,0	9,80	4,34	2,70	1,80	1,40
A512/25 G5	NGA5120025HS0BA	41,1	36,2	24,8	20,5	13,1	5,80	3,90	2,50	2,10
A512/30 G6	NGA5120030HS0BA	60,7	49,3	36,5	28,0	18,0	7,60	4,90	3,20	2,60
A512/40 A	NGA5120040HS0CA	75,0	63,0	42,0	34,0	22,0	8,80	6,40	4,30	3,50
A512/55 A	NGA5120055HS0CA	99,2	83,1	59,1	46,4	32,7	13,6	9,00	6,00	4,90
A512/60 A	NGA5120060HS0CA	122	100	69,2	54,2	33,8	15,3	9,90	6,60	5,40
A512/65 A	NGA5120065HS0CA	95,8	83,1	65,8	56,4	35,8	16,6	11,0	7,40	6,10
A512/85 A	NGA5120085HS0CA	168	141	100	78,0	53,0	22,0	14,2	9,40	7,70
A512/115 A	NGA5120115HS0CA	210	179	128	100	60,0	26,0	18,0	12,0	10,1
A512/120 A	NGA5120120HS0CA	257	201	135	104	65,5	27,8	18,1	11,9	9,80
A512/140 A	NGA5120140HS0CA	275	220	151	118	75,1	32,5	21,3	14,0	11,5
A512/200 A	NGA5120200HS0CA	329	274	196	160	104	46,6	31,0	20,4	16,7

1,80 V/Z – Entladung in A bei 20 °C

Typ	Sachnummer	5 min	10 min	20 min	30 min	1 h	3 h	5 h	8 h	10 h
A502/10 S	NGA5020010HS0SA	33,0	24,0	16,0	11,9	6,80	2,90	1,90	1,23	1,00
A504/3,5 S	NGA50403D5HS0SA	10,6	7,40	4,90	3,70	2,20	0,98	0,62	0,40	0,33
A506/1,2 S	NGA50601D2HS0SA	3,92	2,67	1,69	1,26	0,77	0,35	0,21	0,13	0,10
A506/3,5 S	NGA50603D5HS0SA	10,6	7,40	4,90	3,70	2,20	0,98	0,62	0,40	0,33
A506/4,2 S	NGA50604D2HS0SA	11,7	6,70	4,40	3,40	2,40	1,24	0,77	0,50	0,40
A506/6,5 S	NGA50606D5HS0SA	19,0	13,0	8,80	6,50	3,80	1,60	1,10	0,75	0,63
A506/10 S	NGA5060010HS0SA	33,0	24,0	16,0	11,9	6,80	2,90	1,90	1,23	1,00
A508/3,5 S	NGA50803D5HS0SA	10,6	7,40	4,90	3,70	2,20	0,98	0,62	0,40	0,33
A512/1,2 S	NGA51201D2HS0SA	3,92	2,67	1,69	1,26	0,77	0,35	0,21	0,13	0,10
A512/2 S	NGA5120002HS0SA	6,20	4,20	2,80	2,10	1,50	0,58	0,36	0,23	0,19
A512/3,5 S	NGA51203D5HS0SA	10,6	7,40	4,90	3,70	2,20	0,98	0,62	0,40	0,33
A512/6,5 S	NGA51206D5HS0SA	19,0	13,0	8,80	6,50	3,80	1,60	1,10	0,75	0,63
A512/10 S	NGA5120010HS0SA	33,0	24,0	16,0	11,9	6,80	2,90	1,90	1,23	1,00
A512/16 G5	NGA5120016HS0BA	47,0	33,0	22,0	16,0	10,2	4,40	2,80	1,80	1,50
A512/25 G5	NGA5120025HS0BA	46,1	38,8	27,0	21,3	13,8	6,00	4,00	2,60	2,20
A512/30 G6	NGA5120030HS0BA	75,5	54,8	39,9	30,0	19,1	7,90	5,10	3,30	2,70
A512/40 A	NGA5120040HS0CA	86,0	69,0	47,0	36,0	23,0	9,20	6,70	4,40	3,60
A512/55 A	NGA5120055HS0CA	114	89,8	65,3	50,2	34,2	14,0	9,20	6,10	5,00
A512/60 A	NGA5120060HS0CA	145	108	75,9	58,1	35,5	15,8	10,3	6,80	5,60
A512/65 A	NGA5120065HS0CA	120	100	75,4	60,4	38,6	17,4	11,5	7,50	6,20
A512/85 A	NGA5120085HS0CA	193	154	112	85,0	56,0	23,0	14,7	9,80	8,00
A512/115 A	NGA5120115HS0CA	244	192	140	107	64,0	27,0	18,0	13,0	10,4
A512/120 A	NGA5120120HS0CA	293	221	147	112	69,5	28,9	18,6	12,3	10,2
A512/140 A	NGA5120140HS0CA	315	244	166	128	79,7	33,8	22,0	14,5	11,9
A512/200 A	NGA5120200HS0CA	381	313	222	176	110	48,5	32,0	21,1	17,3

1,75 V/Z – Entladung in A bei 20 °C										
Typ	Sachnummer	5 min	10 min	20 min	30 min	1 h	3 h	5 h	8 h	10 h
A502/10 S	NGA5020010HS0SA	35,0	26,0	17,0	12,3	6,90	3,00	1,90	1,25	1,02
A504/3,5 S	NGA50403D5HS0SA	11,3	7,90	5,10	3,80	2,30	0,99	0,62	0,41	0,34
A506/1,2 S	NGA50601D2HS0SA	4,12	2,82	1,74	1,30	0,78	0,35	0,22	0,13	0,10
A506/3,5 S	NGA50603D5HS0SA	11,3	7,90	5,10	3,80	2,30	0,99	0,62	0,41	0,34
A506/4,2 S	NGA50604D2HS0SA	13,3	6,90	4,40	3,50	2,40	1,25	0,78	0,50	0,41
A506/6,5 S	NGA50606D5HS0SA	20,0	14,0	9,20	6,80	3,90	1,60	1,10	0,76	0,63
A506/10 S	NGA5060010HS0SA	35,0	26,0	17,0	12,3	6,90	3,00	1,90	1,25	1,02
A508/3,5 S	NGA50803D5HS0SA	11,3	7,90	5,10	3,80	2,30	0,99	0,62	0,41	0,34
A512/1,2 S	NGA51201D2HS0SA	4,12	2,82	1,74	1,30	0,78	0,35	0,22	0,13	0,10
A512/2 S	NGA5120002HS0SA	6,80	4,60	2,90	2,20	1,50	0,59	0,36	0,24	0,19
A512/3,5 S	NGA51203D5HS0SA	11,3	7,90	5,10	3,80	2,30	0,99	0,62	0,41	0,34
A512/6,5 S	NGA51206D5HS0SA	20,0	14,0	9,20	6,80	3,90	1,60	1,10	0,76	0,63
A512/10 S	NGA5120010HS0SA	35,0	26,0	17,0	12,3	6,90	3,00	1,90	1,25	1,02
A512/16 G5	NGA5120016HS0BA	51,0	36,0	23,0	17,0	10,4	4,50	2,90	1,80	1,54
A512/25 G5	NGA5120025HS0BA	54,2	41,4	28,6	21,9	14,2	6,10	4,00	2,70	2,20
A512/30 G6	NGA5120030HS0BA	84,7	60,3	42,0	31,3	19,7	8,10	5,20	3,40	2,80
A512/40 A	NGA5120040HS0CA	103	74,0	50,0	37,0	24,0	9,40	6,80	4,50	3,70
A512/55 A	NGA5120055HS0CA	139	99,0	69,5	52,5	35,0	14,2	9,30	6,20	5,10
A512/60 A	NGA5120060HS0CA	168	118	80,4	60,5	36,4	16,1	10,4	6,90	5,60
A512/65 A	NGA5120065HS0CA	140	111	81,9	63,8	40,0	17,8	11,7	7,60	6,30
A512/85 A	NGA5120085HS0CA	226	169	120	90,0	58,0	23,0	15,0	9,90	8,10
A512/115 A	NGA5120115HS0CA	282	204	148	112	66,0	28,0	19,0	13,0	10,5
A512/120 A	NGA5120120HS0CA	330	235	155	116	71,6	29,5	19,0	12,6	10,5
A512/140 A	NGA5120140HS0CA	357	264	176	133	82,3	34,5	22,3	14,8	12,2
A512/200 A	NGA5120200HS0CA	437	349	237	183	115	49,7	32,3	21,5	17,7

1,70 V/Z – Entladung in A bei 20 °C										
Typ	Sachnummer	5 min	10 min	20 min	30 min	1 h	3 h	5 h	8 h	10 h
A502/10 S	NGA5020010HS0SA	37,0	27,0	17,0	12,6	7,00	3,00	1,90	1,25	1,02
A504/3,5 S	NGA50403D5HS0SA	12,1	8,30	5,20	3,90	2,30	1,00	0,63	0,41	0,34
A506/1,2 S	NGA50601D2HS0SA	4,32	2,91	1,77	1,31	0,79	0,35	0,22	0,13	0,10
A506/3,5 S	NGA50603D5HS0SA	12,1	8,30	5,20	3,90	2,30	1,00	0,63	0,41	0,34
A506/4,2 S	NGA50604D2HS0SA	14,2	7,00	4,50	3,50	2,50	1,26	0,79	0,50	0,41
A506/6,5 S	NGA50606D5HS0SA	21,0	15,0	9,50	6,90	3,90	1,60	1,10	0,76	0,63
A506/10 S	NGA5060010HS0SA	37,0	27,0	17,0	12,6	7,00	3,00	1,90	1,25	1,02
A508/3,5 S	NGA50803D5HS0SA	12,1	8,30	5,20	3,90	2,30	1,00	0,63	0,41	0,34
A512/1,2 S	NGA51201D2HS0SA	4,32	2,91	1,77	1,31	0,79	0,35	0,22	0,13	0,10
A512/2 S	NGA5120002HS0SA	7,40	4,80	3,00	2,20	1,50	0,60	0,37	0,24	0,19
A512/3,5 S	NGA51203D5HS0SA	12,1	8,30	5,20	3,90	2,30	1,00	0,63	0,41	0,34
A512/6,5 S	NGA51206D5HS0SA	21,0	15,0	9,50	6,90	3,90	1,60	1,10	0,76	0,63
A512/10 S	NGA5120010HS0SA	37,0	27,0	17,0	12,6	7,00	3,00	1,90	1,25	1,02
A512/16 G5	NGA5120016HS0BA	54,0	39,0	24,0	17,0	10,5	4,60	2,92	1,80	1,54
A512/25 G5	NGA5120025HS0BA	61,7	43,3	29,6	22,4	14,4	6,20	4,10	2,70	2,20
A512/30 G6	NGA5120030HS0BA	92,0	64,3	43,3	32,0	20,0	8,20	5,30	3,40	2,80
A512/40 A	NGA5120040HS0CA	115	79,0	52,0	38,0	24,0	9,50	6,80	4,50	3,70
A512/55 A	NGA5120055HS0CA	151	106	72,0	53,9	35,5	14,3	9,30	6,20	5,10
A512/60 A	NGA5120060HS0CA	178	125	82,6	61,6	36,9	16,2	10,4	6,90	5,60
A512/65 A	NGA5120065HS0CA	158	121	86,2	65,9	40,6	17,9	11,7	7,60	6,30
A512/85 A	NGA5120085HS0CA	244	182	125	93,0	59,0	23,0	15,1	9,90	8,10
A512/115 A	NGA5120115HS0CA	310	215	153	114	67,0	28,0	19,0	13,0	10,5
A512/120 A	NGA5120120HS0CA	367	249	161	119	73,1	29,9	19,2	12,8	10,5
A512/140 A	NGA5120140HS0CA	397	282	183	137	84,1	35,1	22,6	15,0	12,2
A512/200 A	NGA5120200HS0CA	486	380	251	191	117	50,6	32,8	21,8	17,7

1,65 V/Z – Entladung in A bei 20 °C										
Typ	Sachnummer	5 min	10 min	20 min	30 min	1 h	3 h	5 h	8 h	10 h
A502/10 S	NGA5020010HS0SA	39,0	28,0	17,0	12,7	7,10	3,00	1,90	1,25	1,02
A504/3,5 S	NGA50403D5HS0SA	12,7	8,50	5,30	3,90	2,30	1,01	0,63	0,41	0,34
A506/1,2 S	NGA50601D2HS0SA	4,52	2,96	1,79	1,32	0,80	0,36	0,22	0,13	0,10
A506/3,5 S	NGA50603D5HS0SA	12,7	8,50	5,30	3,90	2,30	1,01	0,63	0,41	0,34
A506/4,2 S	NGA50604D2HS0SA	14,8	7,00	4,50	3,50	2,50	1,27	0,79	0,50	0,41
A506/6,5 S	NGA50606D5HS0SA	23,0	15,0	9,60	7,00	4,00	1,60	1,10	0,76	0,63
A506/10 S	NGA5060010HS0SA	39,0	28,0	17,0	12,7	7,10	3,00	1,90	1,25	1,02
A508/3,5 S	NGA50803D5HS0SA	12,7	8,50	5,30	3,90	2,30	1,01	0,63	0,41	0,34
A512/1,2 S	NGA51201D2HS0SA	4,52	2,96	1,79	1,32	0,80	0,36	0,22	0,13	0,10
A512/2 S	NGA5120002HS0SA	7,80	4,90	3,00	2,20	1,50	0,60	0,37	0,24	0,19
A512/3,5 S	NGA51203D5HS0SA	12,7	8,50	5,30	3,90	2,30	1,01	0,63	0,41	0,34
A512/6,5 S	NGA51206D5HS0SA	23,0	15,0	9,60	7,00	4,00	1,60	1,10	0,76	0,63
A512/10 S	NGA5120010HS0SA	39,0	28,0	17,0	12,7	7,10	3,00	1,90	1,25	1,02
A512/16 G5	NGA5120016HS0BA	58,0	41,0	24,0	18,0	10,6	4,60	2,92	1,80	1,54
A512/25 G5	NGA5120025HS0BA	67,5	45,4	30,2	22,7	14,4	6,20	4,10	2,70	2,20
A512/30 G6	NGA5120030HS0BA	98,9	67,0	44,0	32,4	20,1	8,20	5,30	3,40	2,80
A512/40 A	NGA5120040HS0CA	121	82,0	53,0	39,0	24,0	9,50	6,80	4,50	3,70
A512/55 A	NGA5120055HS0CA	161	112	73,6	54,7	35,7	14,4	9,30	6,20	5,10
A512/60 A	NGA5120060HS0CA	185	130	83,2	61,7	37,1	16,2	10,4	6,90	5,60
A512/65 A	NGA5120065HS0CA	178	129	88,8	67,0	40,9	17,9	11,7	7,60	6,30
A512/85 A	NGA5120085HS0CA	259	192	128	94,0	59,0	24,0	15,1	9,90	8,10
A512/115 A	NGA5120115HS0CA	332	222	156	116	67,0	28,0	19,0	13,0	10,5
A512/120 A	NGA5120120HS0CA	387	260	165	122	74,0	30,1	19,2	12,8	10,5
A512/140 A	NGA5120140HS0CA	423	294	189	141	85,4	35,4	22,6	15,0	12,2
A512/200 A	NGA5120200HS0CA	531	395	262	198	120	51,0	32,8	21,8	17,7

1,60 V/Z – Entladung in A bei 20 °C										
Typ	Sachnummer	5 min	10 min	20 min	30 min	1 h	3 h	5 h	8 h	10 h
A502/10 S	NGA5020010HS0SA	42,0	29,0	17,0	12,8	7,10	3,00	1,90	1,25	1,02
A504/3,5 S	NGA50403D5HS0SA	13,1	8,70	5,30	3,90	2,30	1,01	0,63	0,41	0,34
A506/1,2 S	NGA50601D2HS0SA	4,66	3,00	1,80	1,33	0,80	0,36	0,22	0,13	0,10
A506/3,5 S	NGA50603D5HS0SA	13,1	8,70	5,30	3,90	2,30	1,01	0,63	0,41	0,34
A506/4,2 S	NGA50604D2HS0SA	15,2	7,00	4,50	3,50	2,50	1,27	0,79	0,50	0,41
A506/6,5 S	NGA50606D5HS0SA	24,0	16,0	9,70	7,00	4,00	1,60	1,10	0,76	0,63
A506/10 S	NGA5060010HS0SA	42,0	29,0	17,0	12,8	7,10	3,00	1,90	1,25	1,02
A508/3,5 S	NGA50803D5HS0SA	13,1	8,70	5,30	3,90	2,30	1,01	0,63	0,41	0,34
A512/1,2 S	NGA51201D2HS0SA	4,66	3,00	1,80	1,33	0,80	0,36	0,22	0,13	0,10
A512/2 S	NGA5120002HS0SA	8,20	5,00	3,10	2,20	1,50	0,60	0,37	0,24	0,19
A512/3,5 S	NGA51203D5HS0SA	13,1	8,70	5,30	3,90	2,30	1,01	0,63	0,41	0,34
A512/6,5 S	NGA51206D5HS0SA	24,0	16,0	9,70	7,00	4,00	1,60	1,10	0,76	0,63
A512/10 S	NGA5120010HS0SA	42,0	29,0	17,0	12,8	7,10	3,00	1,90	1,25	1,02
A512/16 G5	NGA5120016HS0BA	61,0	42,0	25,0	18,0	10,7	4,61	2,92	1,80	1,54
A512/25 G5	NGA5120025HS0BA	71,8	46,9	30,7	22,9	14,5	6,20	4,10	2,70	2,20
A512/30 G6	NGA5120030HS0BA	105	68,7	44,4	32,6	20,1	8,20	5,30	3,40	2,80
A512/40 A	NGA5120040HS0CA	127	85,0	54,0	39,0	24,0	9,50	6,80	4,50	3,70
A512/55 A	NGA5120055HS0CA	169	116	74,6	55,2	35,8	14,4	9,30	6,20	5,10
A512/60 A	NGA5120060HS0CA	191	133	83,5	61,8	37,2	16,2	10,4	6,90	5,60
A512/65 A	NGA5120065HS0CA	193	135	90,3	67,7	41,1	18,0	11,7	7,60	6,30
A512/85 A	NGA5120085HS0CA	273	199	130	95,0	60,0	24,0	15,1	9,90	8,10
A512/115 A	NGA5120115HS0CA	343	227	158	117	68,0	28,0	19,0	13,0	10,5
A512/120 A	NGA5120120HS0CA	409	267	168	124	74,7	30,2	19,2	12,8	10,5
A512/140 A	NGA5120140HS0CA	452	303	193	143	86,3	35,4	22,6	15,0	12,2
A512/200 A	NGA5120200HS0CA	581	411	269	202	121	51,1	32,8	21,8	17,7

1,85 V/Z – Entladung in W/Block bei 20 °C										
Typ	Sachnummer	3 min	5 min	10 min	15 min	20 min	30 min	45 min	1 h	1,5 h
A502/10 S	NGA5020010HS0SA	56,0	50,0	41,0	33,0	27,0	20,0	16,0	13,0	9,00
A504/3,5 S	NGA50403D5HS0SA	41,0	34,0	26,0	21,0	17,0	13,0	11,0	9,00	6,00
A506/1,2 S	NGA50601D2HS0SA	21,4	17,2	12,2	10,3	8,60	6,60	4,90	4,00	3,00
A506/3,5 S	NGA50603D5HS0SA	62,0	51,0	38,0	32,0	26,0	20,0	16,0	13,0	9,00
A506/4,2 S	NGA50604D2HS0SA	77,0	63,0	44,0	35,0	30,0	23,0	16,0	14,0	11,0
A506/6,5 S	NGA50606D5HS0SA	120	100	73,0	60,0	51,0	38,0	28,0	23,0	16,0
A506/10 S	NGA5060010HS0SA	167	149	124	98,0	80,0	60,0	49,0	39,0	28,0
A508/3,5 S	NGA50803D5HS0SA	83,0	68,0	51,0	42,0	35,0	27,0	22,0	17,0	12,0
A512/1,2 S	NGA51201D2HS0SA	42,7	34,4	24,3	20,7	17,2	13,2	9,80	8,00	5,90
A512/2 S	NGA5120002HS0SA	74,0	60,0	44,0	36,0	30,0	23,0	17,0	14,0	10,0
A512/3,5 S	NGA51203D5HS0SA	124	102	77,0	63,0	52,0	40,0	33,0	26,0	18,0
A512/6,5 S	NGA51206D5HS0SA	240	200	146	120	102	76,0	56,0	46,0	32,0
A512/10 S	NGA5120010HS0SA	335	298	248	195	160	120	98,0	78,0	56,0
A512/16 G5	NGA5120016HS0BA	485	433	352	295	252	192	150	119	87,0
A512/25 G5	NGA5120025HS0BA	535	463	387	324	278	225	170	140	105
A512/30 G6	NGA5120030HS0BA	857	751	568	479	400	310	251	200	144
A512/40 A	NGA5120040HS0CA	958	848	703	578	490	395	300	243	178
A512/55 A	NGA5120055HS0CA	1348	1172	922	844	718	572	457	367	269
A512/60 A	NGA5120060HS0CA	1618	1414	1096	963	807	625	459	369	271
A512/65 A	NGA5120065HS0CA	1180	1113	991	861	763	659	500	411	307
A512/85 A	NGA5120085HS0CA	1979	1802	1527	1310	1118	905	690	565	425
A512/115 A	NGA5120115HS0CA	2808	2531	2009	1705	1439	1155	872	702	512
A512/120 A	NGA5120120HS0CA	3350	2862	2300	1895	1583	1200	938	757	583
A512/140 A	NGA5120140HS0CA	3674	3172	2549	2101	1755	1330	1040	839	647
A512/200 A	NGA5120200HS0CA	4690	4102	3449	2843	2375	1800	1408	1135	875

1,80 V/Z – Entladung in W/Block bei 20 °C										
Typ	Sachnummer	3 min	5 min	10 min	15 min	20 min	30 min	45 min	1 h	1,5 h
A502/10 S	NGA5020010HS0SA	56,0	53,0	44,0	35,0	29,0	21,0	17,0	14,0	10,0
A504/3,5 S	NGA50403D5HS0SA	45,0	38,0	28,0	22,0	19,0	14,0	11,0	9,00	6,00
A506/1,2 S	NGA50601D2HS0SA	23,5	19,1	13,3	10,9	9,10	6,90	5,10	4,10	3,00
A506/3,5 S	NGA50603D5HS0SA	68,0	57,0	42,0	33,0	28,0	21,0	17,0	13,0	10,0
A506/4,2 S	NGA50604D2HS0SA	83,0	71,0	49,0	39,0	35,0	31,0	17,0	14,0	11,0
A506/6,5 S	NGA50606D5HS0SA	128	112	80,0	63,0	54,0	40,0	30,0	24,0	17,0
A506/10 S	NGA5060010HS0SA	168	159	131	104	86,0	64,0	51,0	41,0	29,0
A508/3,5 S	NGA50803D5HS0SA	91,0	76,0	56,0	44,0	37,0	28,0	23,0	18,0	13,0
A512/1,2 S	NGA51201D2HS0SA	47,0	38,3	26,5	21,7	18,1	13,7	10,2	8,20	6,00
A512/2 S	NGA5120002HS0SA	83,0	68,0	49,0	38,0	32,0	24,0	18,0	15,0	11,0
A512/3,5 S	NGA51203D5HS0SA	136	114	84,0	66,0	56,0	42,0	34,0	27,0	19,0
A512/6,5 S	NGA51206D5HS0SA	256	224	160	126	108	80,0	60,0	48,0	34,0
A512/10 S	NGA5120010HS0SA	336	318	261	209	172	128	101	81,0	59,0
A512/16 G5	NGA5120016HS0BA	584	485	384	309	269	203	156	124	90,0
A512/25 G5	NGA5120025HS0BA	623	555	418	360	303	240	180	146	109
A512/30 G6	NGA5120030HS0BA	1036	850	637	517	433	330	264	210	151
A512/40 A	NGA5120040HS0CA	1092	1007	758	646	538	415	318	255	186
A512/55 A	NGA5120055HS0CA	1555	1362	1014	888	777	606	478	382	278
A512/60 A	NGA5120060HS0CA	1955	1634	1181	1041	873	669	489	390	283
A512/65 A	NGA5120065HS0CA	1459	1316	1109	989	851	693	544	441	327
A512/85 A	NGA5120085HS0CA	2279	2132	1684	1487	1245	970	740	600	447
A512/115 A	NGA5120115HS0CA	3189	2873	2190	1888	1569	1209	926	739	535
A512/120 A	NGA5120120HS0CA	3763	3276	2543	2027	1720	1285	966	794	608
A512/140 A	NGA5120140HS0CA	4127	3631	2819	2246	1906	1424	1070	880	674
A512/200 A	NGA5120200HS0CA	5268	4695	3815	3040	2580	1928	1449	1191	912



1,75 V/Z – Entladung in W/Block bei 20 °C										
Typ	Sachnummer	3 min	5 min	10 min	15 min	20 min	30 min	45 min	1 h	1,5 h
A502/10 S	NGA5020010HS0SA	60,0	58,0	45,0	36,0	30,0	22,0	17,0	14,0	10,0
A504/3,5 S	NGA50403D5HS0SA	49,0	41,0	30,0	23,0	20,0	15,0	12,0	9,00	6,00
A506/1,2 S	NGA50601D2HS0SA	25,1	20,7	14,0	11,1	9,30	7,00	5,20	4,20	3,00
A506/3,5 S	NGA50603D5HS0SA	73,0	62,0	45,0	35,0	29,0	22,0	18,0	14,0	10,0
A506/4,2 S	NGA50604D2HS0SA	89,0	77,0	52,0	40,0	36,0	31,0	17,0	15,0	11,0
A506/6,5 S	NGA50606D5HS0SA	138	121	86,0	66,0	57,0	42,0	30,0	24,0	17,0
A506/10 S	NGA5060010HS0SA	181	173	135	109	90,0	66,0	51,0	42,0	30,0
A508/3,5 S	NGA50803D5HS0SA	97,0	82,0	60,0	46,0	39,0	29,0	23,0	18,0	13,0
A512/1,2 S	NGA51201D2HS0SA	50,1	41,4	28,0	22,2	18,6	14,0	10,3	8,30	6,10
A512/2 S	NGA5120002HS0SA	91,0	75,0	52,0	40,0	33,0	25,0	18,0	15,0	11,0
A512/3,5 S	NGA51203D5HS0SA	146	123	89,0	69,0	59,0	44,0	35,0	27,0	19,0
A512/6,5 S	NGA51206D5HS0SA	276	242	172	132	114	84,0	60,0	48,0	34,0
A512/10 S	NGA5120010HS0SA	361	346	270	219	179	132	103	83,0	60,0
A512/16 G5	NGA5120016HS0BA	636	534	407	322	280	209	159	126	91,0
A512/25 G5	NGA5120025HS0BA	689	616	454	385	320	248	185	150	111
A512/30 G6	NGA5120030HS0BA	1118	951	690	538	453	341	271	214	153
A512/40 A	NGA5120040HS0CA	1226	1074	822	691	569	432	326	261	189
A512/55 A	NGA5120055HS0CA	1799	1496	1102	917	813	626	489	388	281
A512/60 A	NGA5120060HS0CA	2267	1837	1274	1071	915	693	505	400	288
A512/65 A	NGA5120065HS0CA	1757	1591	1223	1083	914	721	567	457	336
A512/85 A	NGA5120085HS0CA	2561	2292	1847	1557	1329	1018	768	621	460
A512/115 A	NGA5120115HS0CA	3642	3101	2374	1986	1653	1255	956	759	547
A512/120 A	NGA5120120HS0CA	4237	3552	2627	2134	1800	1334	989	815	622
A512/140 A	NGA5120140HS0CA	4647	3937	2912	2365	1995	1479	1096	904	689
A512/200 A	NGA5120200HS0CA	5932	5092	3941	3201	2700	2002	1484	1223	933

1,70 V/Z – Entladung in W/Block bei 20 °C										
Typ	Sachnummer	3 min	5 min	10 min	15 min	20 min	30 min	45 min	1 h	1,5 h
A502/10 S	NGA5020010HS0SA	64,0	60,0	46,0	38,0	31,0	22,0	17,0	14,0	10,0
A504/3,5 S	NGA50403D5HS0SA	53,0	44,0	31,0	24,0	20,0	15,0	12,0	9,00	7,00
A506/1,2 S	NGA50601D2HS0SA	26,8	21,9	14,4	11,2	9,40	7,10	5,20	4,20	3,10
A506/3,5 S	NGA50603D5HS0SA	80,0	66,0	46,0	36,0	30,0	22,0	18,0	14,0	10,0
A506/4,2 S	NGA50604D2HS0SA	97,0	81,0	54,0	41,0	36,0	32,0	17,0	15,0	11,0
A506/6,5 S	NGA50606D5HS0SA	150	126	88,0	68,0	58,0	42,0	31,0	24,0	17,0
A506/10 S	NGA5060010HS0SA	193	180	139	113	92,0	67,0	52,0	42,0	30,0
A508/3,5 S	NGA50803D5HS0SA	106	88,0	61,0	48,0	40,0	30,0	24,0	19,0	13,0
A512/1,2 S	NGA51201D2HS0SA	53,7	43,7	28,8	22,4	18,8	14,1	10,4	8,40	6,10
A512/2 S	NGA5120002HS0SA	99,0	80,0	53,0	41,0	34,0	25,0	19,0	15,0	11,0
A512/3,5 S	NGA51203D5HS0SA	159	131	92,0	72,0	60,0	45,0	35,0	28,0	20,0
A512/6,5 S	NGA51206D5HS0SA	300	252	176	136	116	84,0	62,0	48,0	34,0
A512/10 S	NGA5120010HS0SA	385	360	278	226	185	135	103	84,0	60,0
A512/16 G5	NGA5120016HS0BA	688	573	418	331	285	212	161	127	91,0
A512/25 G5	NGA5120025HS0BA	776	652	482	395	330	253	187	151	112
A512/30 G6	NGA5120030HS0BA	1214	1037	726	558	465	347	274	216	155
A512/40 A	NGA5120040HS0CA	1391	1157	870	719	587	441	331	264	191
A512/55 A	NGA5120055HS0CA	1912	1624	1163	935	834	636	493	392	283
A512/60 A	NGA5120060HS0CA	2406	2022	1348	1088	940	707	514	405	290
A512/65 A	NGA5120065HS0CA	1959	1739	1322	1142	954	739	577	464	340
A512/85 A	NGA5120085HS0CA	2900	2486	1993	1607	1381	1045	786	634	469
A512/115 A	NGA5120115HS0CA	4106	3361	2511	2030	1703	1281	971	770	553
A512/120 A	NGA5120120HS0CA	4536	3800	2690	2201	1849	1365	1008	830	632
A512/140 A	NGA5120140HS0CA	4974	4211	2981	2440	2050	1513	1117	920	700
A512/200 A	NGA5120200HS0CA	6350	5446	4034	3302	2774	2048	1512	1245	948

1,65 V/Z – Entladung in W/Block bei 20 °C										
Typ	Sachnummer	3 min	5 min	10 min	15 min	20 min	30 min	45 min	1 h	1,5 h
A502/10 S	NGA5020010HS0SA	68,0	62,0	47,0	38,0	31,0	23,0	17,0	14,0	10,0
A504/3,5 S	NGA50403D5HS0SA	57,0	46,0	31,0	24,0	20,0	15,0	12,0	9,00	7,00
A506/1,2 S	NGA50601D2HS0SA	28,2	22,6	14,7	11,2	9,50	7,10	5,20	4,20	3,10
A506/3,5 S	NGA50603D5HS0SA	85,0	68,0	47,0	36,0	30,0	23,0	18,0	14,0	10,0
A506/4,2 S	NGA50604D2HS0SA	102	82,0	55,0	41,0	36,0	32,0	17,0	15,0	11,0
A506/6,5 S	NGA50606D5HS0SA	160	129	90,0	69,0	59,0	43,0	31,0	25,0	18,0
A506/10 S	NGA5060010HS0SA	205	186	142	114	93,0	68,0	52,0	42,0	30,0
A508/3,5 S	NGA50803D5HS0SA	113	91,0	62,0	49,0	41,0	30,0	24,0	19,0	13,0
A512/1,2 S	NGA51201D2HS0SA	56,4	45,3	29,4	22,5	18,9	14,2	10,5	8,40	6,10
A512/2 S	NGA5120002HS0SA	103	82,0	54,0	41,0	34,0	25,0	19,0	15,0	11,0
A512/3,5 S	NGA51203D5HS0SA	170	137	93,0	73,0	61,0	45,0	35,0	28,0	20,0
A512/6,5 S	NGA51206D5HS0SA	320	258	180	138	118	86,0	62,0	50,0	36,0
A512/10 S	NGA5120010HS0SA	410	371	283	229	187	136	104	84,0	61,0
A512/16 G5	NGA5120016HS0BA	741	601	423	335	288	213	161	128	92,0
A512/25 G5	NGA5120025HS0BA	854	693	501	400	335	255	188	152	112
A512/30 G6	NGA5120030HS0BA	1310	1095	746	569	471	351	276	217	155
A512/40 A	NGA5120040HS0CA	1514	1235	902	729	597	446	333	265	192
A512/55 A	NGA5120055HS0CA	2005	1726	1204	945	845	642	496	394	284
A512/60 A	NGA5120060HS0CA	2548	2176	1404	1098	954	715	519	409	292
A512/65 A	NGA5120065HS0CA	2139	1853	1395	1171	976	749	582	466	341
A512/85 A	NGA5120085HS0CA	3115	2719	2109	1663	1410	1060	797	642	474
A512/115 A	NGA5120115HS0CA	4304	3582	2603	2057	1732	1296	980	776	557
A512/120 A	NGA5120120HS0CA	4847	4002	2761	2246	1883	1387	1022	843	640
A512/140 A	NGA5120140HS0CA	5316	4435	3060	2489	2087	1538	1133	934	709
A512/200 A	NGA5120200HS0CA	6786	5736	4142	3369	2825	2081	1533	1264	959

1,60 V/Z – Entladung in W/Block bei 20 °C										
Typ	Sachnummer	3 min	5 min	10 min	15 min	20 min	30 min	45 min	1 h	1,5 h
A502/10 S	NGA5020010HS0SA	73,0	63,0	48,0	38,0	31,0	23,0	17,0	14,0	10,0
A504/3,5 S	NGA50403D5HS0SA	59,0	46,0	32,0	25,0	20,0	15,0	12,0	9,00	7,00
A506/1,2 S	NGA50601D2HS0SA	29,2	23,1	14,8	11,3	9,50	7,10	5,20	4,20	3,10
A506/3,5 S	NGA50603D5HS0SA	89,0	69,0	47,0	37,0	31,0	23,0	18,0	14,0	10,0
A506/4,2 S	NGA50604D2HS0SA	106	83,0	55,0	42,0	37,0	32,0	17,0	15,0	11,0
A506/6,5 S	NGA50606D5HS0SA	168	132	92,0	70,0	59,0	43,0	31,0	25,0	18,0
A506/10 S	NGA5060010HS0SA	218	190	144	115	94,0	68,0	52,0	42,0	30,0
A508/3,5 S	NGA50803D5HS0SA	119	93,0	63,0	49,0	41,0	30,0	24,0	19,0	13,0
A512/1,2 S	NGA51201D2HS0SA	58,4	46,2	29,7	22,5	19,0	14,2	10,5	8,40	6,20
A512/2 S	NGA5120002HS0SA	106	84,0	55,0	42,0	34,0	25,0	19,0	15,0	11,0
A512/3,5 S	NGA51203D5HS0SA	178	139	95,0	74,0	61,0	45,0	36,0	28,0	20,0
A512/6,5 S	NGA51206D5HS0SA	336	264	184	140	118	86,0	62,0	50,0	36,0
A512/10 S	NGA5120010HS0SA	437	381	287	231	188	136	104	85,0	61,0
A512/16 G5	NGA5120016HS0BA	783	621	426	338	289	214	162	128	92,0
A512/25 G5	NGA5120025HS0BA	908	725	514	403	339	256	189	153	113
A512/30 G6	NGA5120030HS0BA	1393	1121	755	576	474	352	276	218	156
A512/40 A	NGA5120040HS0CA	1577	1299	923	735	603	449	334	266	192
A512/55 A	NGA5120055HS0CA	2107	1800	1231	957	851	645	498	395	285
A512/60 A	NGA5120060HS0CA	2680	2279	1439	1104	963	719	522	410	293
A512/65 A	NGA5120065HS0CA	2315	1976	1443	1183	987	754	584	468	342
A512/85 A	NGA5120085HS0CA	3264	2923	2190	1700	1427	1069	804	648	477
A512/115 A	NGA5120115HS0CA	4467	3755	2665	2073	1750	1306	985	780	560
A512/120 A	NGA5120120HS0CA	5135	4156	2812	2276	1906	1403	1032	852	646
A512/140 A	NGA5120140HS0CA	5631	4606	3117	2522	2113	1555	1144	945	716
A512/200 A	NGA5120200HS0CA	7189	5957	4218	3413	2860	2104	1548	1279	969

GNB[®] INDUSTRIAL POWER



Exide Technologies ist mit Niederlassungen in mehr als 80 Ländern einer der weltweit größten Hersteller und Recycler von Blei-Säure-Batterien. Exide bietet ein umfassendes und auf Kunden zugeschnittenes Programm für Lösungen zur Speicherung elektrischer Energie.

Mit mehr als 100 Jahren Erfahrung in der Entwicklung innovativer Technologien ist Exide geschätzter Partner der Erstausrüster und bedient den Ersatzteilmarkt für Anwendungen in der Industrie und im Verkehrswesen. Der Geschäftsbereich GNB Industrial Power bietet eine umfangreiche Palette an Speicherprodukten und Dienstleistungen. Hierzu gehören

Anwendungen für Telekommunikationssysteme, für den Schienenverkehr, den Bergbau, der Photovoltaik (Solarstrom), für unterbrechungsfreie Stromversorgung (USV), der Energieversorgung und -verteilung sowie für Gabelstapler und Elektrofahrzeuge.

Exide Technologies ist stolz auf seine Bestrebungen zum Umweltschutz. Das Unternehmen hat ein umfassendes Management-Programm (einen integrierten Ansatz für die Herstellung, den Vertrieb und das Recycling von Bleisäureakkumulatoren) ins Leben gerufen, um den gesamten Lebenszyklus seiner Produkte sicher und verantwortungsbewusst zu gestalten.