

**INDUSTRIAL**  
BY DURACELL®

**ID2400**  
**Size: AAA (LR03)**  
Alkaline-Manganese Dioxide Battery

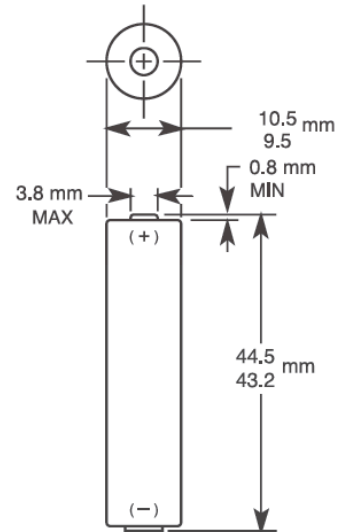

Nominal voltage	1.5 V
Impedance	250 m-ohm @ 1 kHz
Typical weight	11 g (0.4 oz)
Typical volume	3.5 cm <sup>3</sup> (0.2 in <sup>3</sup> )
Terminals	Flat
Storage temperature range	5°C to 30°C (41°F to 86°F)
Operating temperature range	-20°C to 54°C (-4°F to 130°F)
Designation	IEC: LR03



Dimensions shown are IEC standards

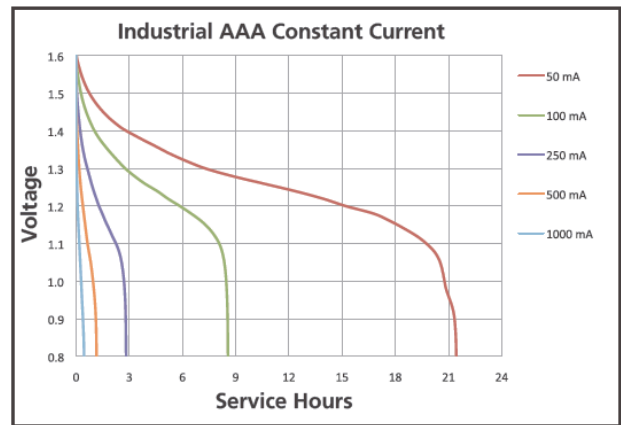
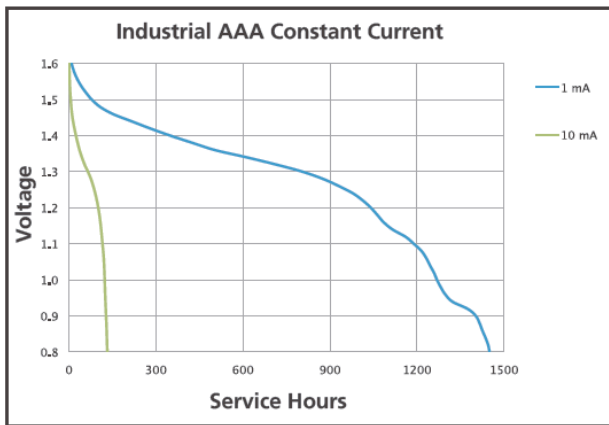

**DURACELL®**  
BATTERIES

Berkshire Corporate Park  
Bethel, CT. 06801 U.S.A.  
Telephone: Toll-free 1-800-544-5454  
www.duracell.com

Delivered capacity is dependent on the applied load, operating temperature and cut-off voltage. Please refer to the charts and discharge data shown for examples of the energy/service life that the battery will provide for various load conditions.

This data is subject to change. Performance information is typical. Contact Duracell for the latest information.

**ID24INWE0514**

Page 1 of 2

**INDUSTRIAL**  
BY DURACELL®

**ID2400**  
**Size: AAA (LR03)**  
Alkaline-Manganese Dioxide Battery

Zn/MnO<sub>2</sub>

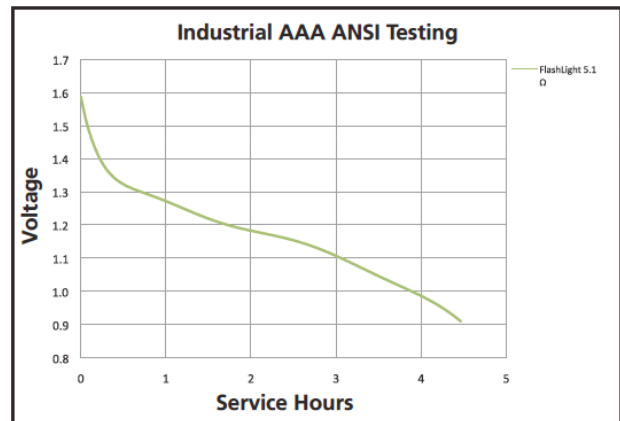
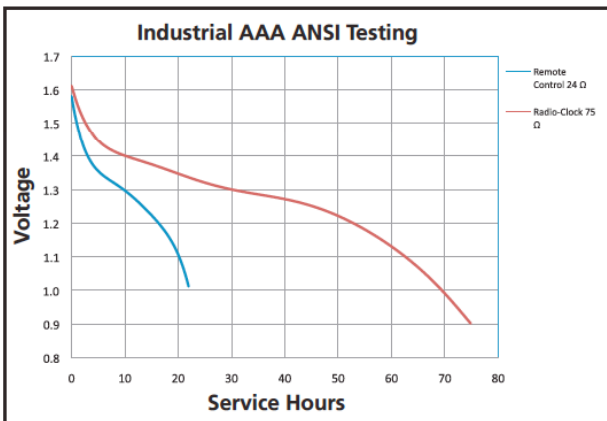
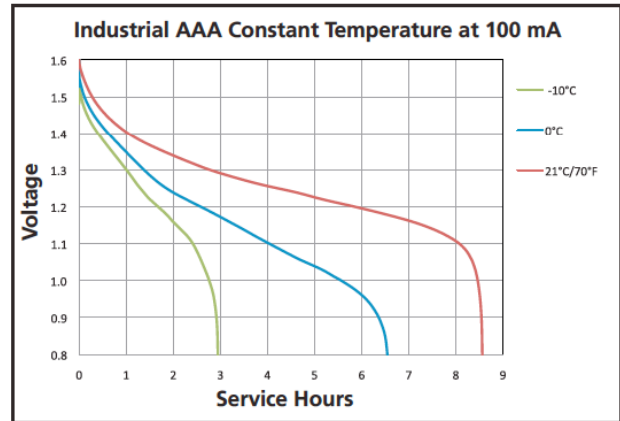
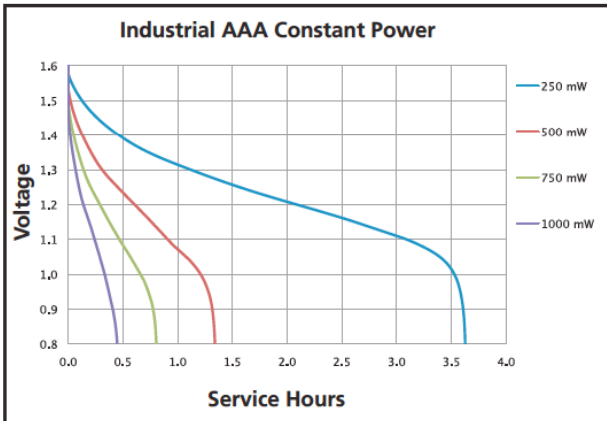

**DURACELL®**  
BATTERIES

Berkshire Corporate Park  
Bethel, CT. 06801 U.S.A.  
Telephone: Toll-free 1-800-544-5454  
www.duracell.com

Delivered capacity is dependent on the applied load, operating temperature and cut-off voltage. Please refer to the charts and discharge data shown for examples of the energy/service life that the battery will provide for various load conditions.

This data is subject to change. Performance information is typical. Contact Duracell for the latest information.

**ID24INWE0514**

Page 2 of 2